

EN Instructions for Use for devices of type WM090TD



prisma SMART plus/max **prisma SOFT plus/max**

Sleep therapy devices



Contents

1	Introduction	4
1.1	Intended use	4
1.2	Description of function	4
1.3	User qualifications	4
1.4	Indications	4
1.5	Contraindications	4
1.6	Side effects	5
1.7	Clinical benefit	6
2	Safety	7
2.1	Safety information	7
2.2	General information	8
2.3	Warnings in this document	9
3	Product description	10
3.1	Overview	10
3.2	Operating states	11
3.3	Control panel	11
3.4	Symbols in the display	12
3.5	Accessories	13
4	Preparation and operation	14
4.1	Setting up and connecting the device	14
4.2	Starting therapy	16
4.3	Ending therapy/switching off device	16
4.4	Setting humidifier	16
4.5	Performing the mask test	17
4.6	Switching softSTART on and off	17
4.7	Using SD card (optional)	18
4.8	Using the modem	19
5	Menu settings	22
5.1	Function of the keys	22
5.2	Settings menu	22

5.3	Info menu/reading out operating hours	24
6	Hygiene treatment	25
6.1	General information	25
6.2	Cleaning intervals	25
6.3	Hygiene treatment for device	26
6.4	Hygiene treatment for breathing tube	28
7	Function check	28
8	Troubleshooting	29
8.1	Device faults	29
8.2	Display messages	30
9	Transport and storage	32
10	Disposal	32
11	Appendix	33
11.1	Technical data	33
11.2	Emission of electromagnetic interference	38
11.3	Electromagnetic interference immunity	39
11.4	Electromagnetic interference immunity for medical electrical devices and medical electrical systems	40
11.5	Markings and symbols	40
11.6	Scope of supply	42
11.7	Accessories and replacement parts	43
11.8	Warranty	43
11.9	Declaration of Conformity	43

1 Introduction

1.1 Intended use

Devices of the WM090TD type are pressure-controlled, non-invasive, non-life-supporting therapy devices for treating sleep-related breathing disorders (SRBDs) using a mask. The devices can be used on persons weighing 30 kg or more. CPAP mode can be used on persons aged 3 years upward regardless of body weight. The device may only be used on a physician's instructions. (auto)CPAP mode provides positive airway pressure for treating sleep-related breathing disorders in patients who breathe spontaneously. Devices of the WM090TD type are used in clinical facilities and in the domestic environment. In the domestic environment, the devices also accompany the owner on trips away.

1.2 Description of function

A blower takes in ambient air through a filter and pumps it to the patient at therapy pressure through the patient circuit and the patient/ventilator interface. The user interface is for displaying and setting the available parameters.

1.3 User qualifications

The person operating the device is referred to in these Instructions for Use as the user. A patient, on the other hand, is the person receiving the therapy.

As an owner/operator or user, you must be familiar with the operation of this medical device. The owner/operator is responsible for ensuring the compatibility of the device and of all the components or accessories associated with the patient before use.

When the device is handed over to the patient, as the attending physician or medical specialist you must provide instruction in the function of the device.

Notice for blind or partially-sighted users

An electronic version of the instructions for use is also available on the website.

1.4 Indications

Therapy devices for treating sleep-related breathing disorders (SRBDs).

1.5 Contraindications

The therapy devices must not be used in the case of:

- No spontaneous breathing or acute respiratory failure
- Loss of consciousness, impaired consciousness or coma
- Pneumothorax or pneumomediastinum
- Pneumoencephalus or liquor fistula

- Severe injuries to the head or face
- Severe epistaxis
- High risk of barotrauma
- Displaced airway
- Inadequate ability to cough
- Middle ear infection or perforated eardrum
- Other acute intolerance of elevated pressure in the upper respiratory tract

The therapy devices must only be used with caution and following assessment by a physician in the case of:

- Acute cardiac decompensation, acute cardiac infarction
- Severe cardiac arrhythmias
- Severe hypotension, especially in combination with intravascular volume depletion
- Severe cardiac insufficiency
- Dehydration
- Acute sinusitis or infection of the upper respiratory tract
- Chronic infection of the respiratory tract or middle ear

1.6 Side effects

The following side effects may be caused by the overpressure generated by the therapy device and the respiration support:

- Sensation of therapy pressure found unpleasant, especially in the upper respiratory tract or in the ribcage
- Aerophagia, flatulence
- Headache
- Earache, otitis
- Aspiration
- Fatigue
- Anxiety, feeling of dependency on therapy device
- Tinnitus
- Eructation

- Periodic leg movements
- Hypoventilation, extended episodes of oxygen desaturation

If the following side effects occur, they may be reduced by using a humidifier and/or a perfectly suited breathing mask:

- Mouth, throat or upper respiratory tract feeling dry
- (Allergic) rhinitis, rhinorrhea
- Sinusitis
- Epistaxis

If the following side effects occur, they may be reduced by using comfort functions on the therapy device or by optimizing therapy settings:

- Exhalation rendered more difficult
- Feeling of breathlessness
- Central sleep apnea
- Disturbed sleep, insomnia

The potential side effects listed arise as a result of the mechanism of action of positive airway pressure and are not attributable specifically to use of devices of the WM090TD type.

Other side effects may be caused by the use of accessory components such as breathing mask or humidifier. See the Instructions for Use for the accessory in question to find out more.

1.7 Clinical benefit

- Correction of breathing regulation during sleep
- Improved quality of sleep
- Reduced sleepiness during the day
- Improved quality of life
- Reduced blood pressure (in patients with hypertension)

2 Safety

2.1 Safety information

2.1.1 Handling the device, the components, and the accessories

If the device is damaged or its function is restricted, patients, users, and people in the vicinity may be injured.

- ⇒ Only operate the device and its components if they are externally undamaged.
- ⇒ Perform a function check at regular intervals (see "7 Function check", page 28).
- ⇒ Only operate the device within the specified ambient conditions (see "11.1 Technical data", page 33).
- ⇒ Do not reuse disposables. Disposables may be contaminated and/or their function may be impaired.
- ⇒ Water and dirt in the device may damage the device.
- ⇒ Only transport the device with the cover fitted.
- ⇒ Transport the device in the associated carrying bag.
- ⇒ Do not transport or tilt the device with the humidifier full.
- ⇒ Use the gray air filter.
- ⇒ Use the white pollen filter (optional accessory) if required.
- ⇒ Set up the device at least 20 cm away from any people.

2.1.2 Energy supply

Operating the device outside the specified energy supply may injure the user and damage the device.

- ⇒ Operate the device only with the power supply unit provided on voltages from 100 V to 240 V.
- ⇒ Use the DC adapter for operation on voltages of 12 V or 24 V.
- ⇒ Keep access to the power supply connector and the power supply free at all times.

2.1.3 Handling oxygen

Supplying oxygen without a special safety device can lead to fire and injure people.

- ⇒ Follow the Instructions for Use for the oxygen supply system.
- ⇒ Set up oxygen sources at a distance of over 1 m from the device.
- ⇒ At the end of therapy, shut off the oxygen supply and allow the device to run on briefly to flush residual oxygen out of the device.

2.2 General information



- The use of third-party articles may lead to incompatibility with the device. In such cases, please be aware that any claim under warranty and liability will be void if neither the accessories nor the original replacement parts recommended in the instructions for use are used.
- Have measures such as repairs, servicing, and maintenance work carried out by the manufacturer or by specialists expressly so authorized by the manufacturer.
- Connect only the devices and modules approved in accordance with these Instructions for Use. The devices must meet the product standard applicable to them. Non-medical equipment should be positioned out of the patient's vicinity.
- The device is subject to special precautions with regard to EMC (electromagnetic compatibility). Maintain a minimum distance of 30 cm between the device and equipment that emits HF radiation (e.g. cell phones). This also applies to accessories such as antenna cables and external antennas, for example. Ignoring this requirement may lead to the device exhibiting reduced performance characteristics.
- Do not operate the device outside the EMC environment specified for this device (see "[1.1 Intended use](#)", page 4) in order to prevent undesired events for the patient or owner/operator due to electromagnetic interference. Do not operate the device if the housing, cables or other equipment for electromagnetic shielding are damaged.
- Do not operate the device in the immediate vicinity of other devices or in a stacked arrangement, otherwise there may be malfunctions. If it is necessary to operate the device in the immediate vicinity of other devices or in a stacked arrangement, keep all the devices under observation to ensure that they are all operating properly.
- Only use accessory parts from the manufacturer. Third-party electrical connecting cables, in particular, may cause the device to malfunction.
- In combination with the device itself, the use of tube heating will generate a slightly higher temperature at the patient connection opening.
- The owner/operator is responsible for ensuring that the setting of the therapeutic pressure has been determined for each patient individually with the device configuration, including accessories, to be used.
- The owner/operator should regularly assess the effectiveness of the therapeutic settings.
- To prevent infection or bacterial contamination, follow the section about hygiene treatment (see "[6 Hygiene treatment](#)", page 25).

- Keep therapy device and accessories away from children and pets. Store therapy device in carrying bag when not in use or being transported.
- In the EU: As a user and/or patient, you must report any serious incidents occurring in conjunction with the product to the manufacturer and to the responsible authority.
- When operating in aircraft, activate flight mode (see "5.2 Settings menu", page 22).

2.3 Warnings in this document

Warnings indicate information relevant to safety.

Within procedures, you will find warnings in front of a step which contains a hazard to persons or objects.

 WARNING	<i>Warning!</i> Indicates an unusually significant hazardous situation. If you ignore this instruction, severe irreversible or fatal injuries may result.
 CAUTION	<i>Caution!</i> Indicates a hazardous situation. If you do not follow this instruction, mild or moderate injuries may result.
NOTICE	<i>Notice!</i> Indicates a harmful situation. If you do not follow this instruction, material damage may result.
	Indicates useful information within procedures.

3 Product description

3.1 Overview

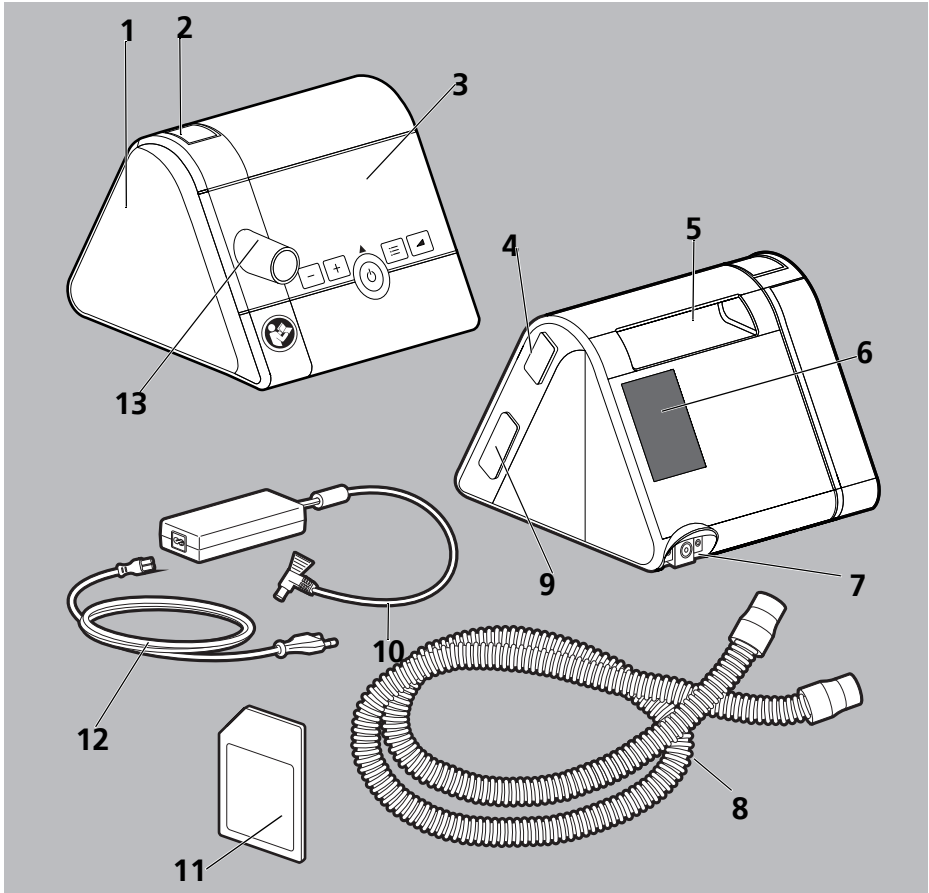

- 1 Humidifier connection with cover
- 2 Release catch
- 3 Control panel with display
- 4 Interface for connecting the communication module
- 5 Handle
- 6 Filter compartment
- 7 Power cord connection
- 8 Breathing tube with connection for breathing mask

- 9 SD card slot
- 10 Power supply unit
- 11 SD card
- 12 Power cord
- 13 Device outlet port

3.2 Operating states

- **On:** Therapy is running.
- **Standby:** Blower is off, but immediately operational if the On/off key is pressed briefly. Settings can be made on the device when it is in standby mode.
- **Off:** the device is de-energized. No settings can be made and the display remains dark.



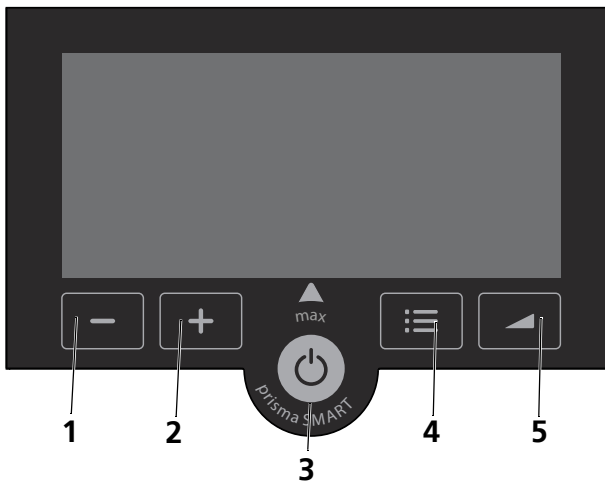

















3.3 Control panel



- 1  key*
- 2  key*
- 3 On/off key*
- 4 Menu key*
- 5 softSTART key*

* The keys of the device may have different functions. If there is a symbol above the key in the display, the key adopts the function of the symbol in question. If there is no symbol above the key, the key retains its original function.

3.4 Symbols in the display

SYMBOL	DESCRIPTION
	Orange symbol: expert area active. White symbol: parameters enabled for patient.
	Parameter is disabled for patient.
	Info menu
	Settings menu
	softSTART symbol
	Green symbol: SD card inserted. When the symbol is flashing, data are being written to the SD card.
	Orange symbol: SD card fault
	Leak display. Mask or tube leaking.
	White symbol: Humidifier connected.
	Green symbol: Humidifier switched on.
	White symbol: Modem available
	Green symbol: Modem transmitting data
	Back to start screen
	Cancel
	Forward one menu item
	Back one menu item
	Confirms the current selection.
	Selection adopted successfully.
	Flight mode (no wireless)
	Bluetooth® (wireless technology)

3.5 Accessories

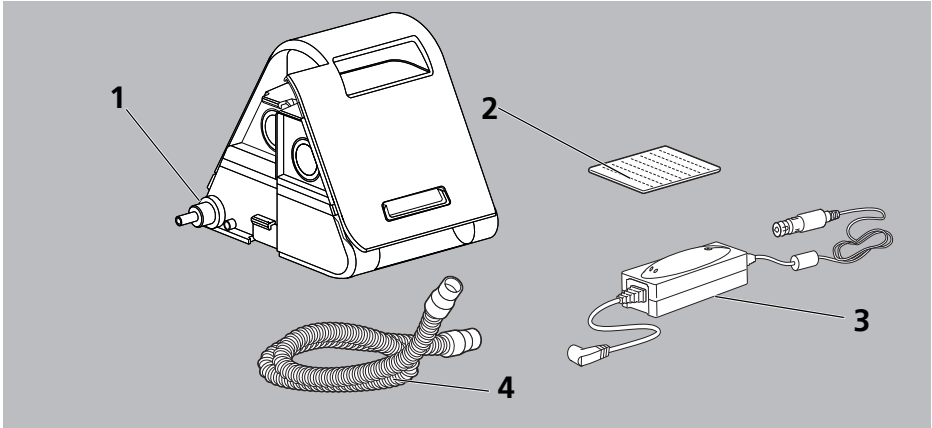

- 1 Humidifier
- 2 Pollen filter (white)
- 3 12-24 V DC adapter
- 4 Breathing tube with 15 mm/19 mm diameter

4 Preparation and operation

4.1 Setting up and connecting the device

⚠ WARNING

Risk of injury due to contaminated or infected patient circuit!

A contaminated or infected patient circuit may transmit contamination or infections to the next patient.

- ⇒ Do not reprocess disposable circuits.
- ⇒ Subject reusable patient circuits to the correct hygiene treatment.

NOTICE

Material damage from overheating!

Excessive temperatures may lead to the device overheating and damage the device.

- ⇒ Do not cover device and power supply unit with textiles (e.g. bedclothes).
- ⇒ Do not operate device in the vicinity of a radiator.
- ⇒ Do not expose device to direct sunlight.
- ⇒ Do not operate device in the carrying bag.

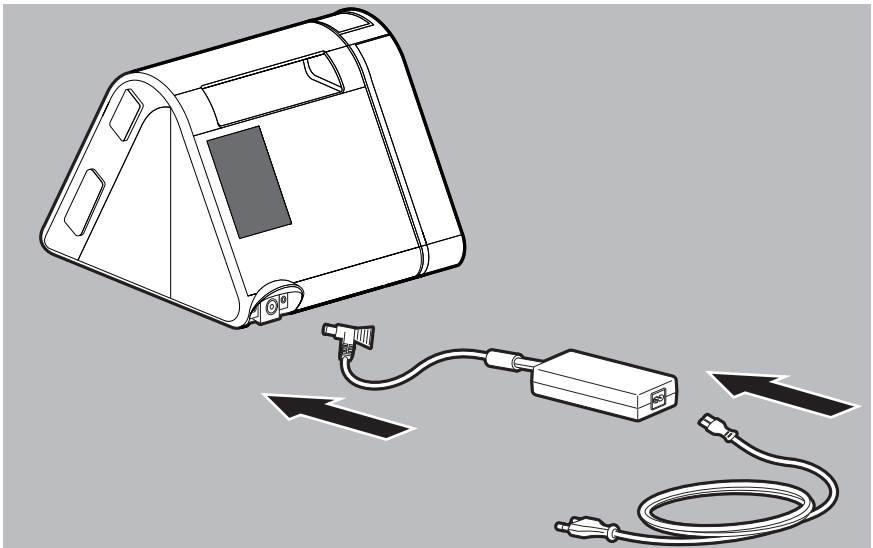

1. Connect the power supply unit to the device.

2. Connect the power cord to the power supply unit and the socket. The operating hours of the device are displayed briefly. The device switches to standby.

⚠ CAUTION

Risk of injury if breathing tube routed incorrectly!

An incorrectly routed breathing tube may injure the patient.

- ⇒ Never wrap the breathing tube around the neck.
- ⇒ Do not crush the breathing tube.

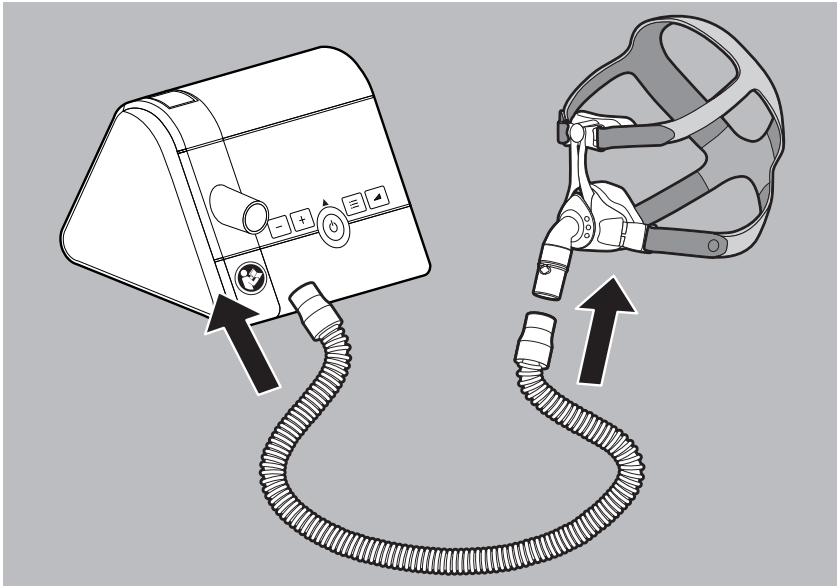

3. Push breathing tube onto the device outlet port.

⚠ WARNING

Risk of suffocation if full-face masks without an exhalation system are used!

If full-face masks without an exhalation system are used, the CO₂ concentration may rise to critical values and put the patient at risk.

- ⇒ Use full-face masks with an external exhalation system if there is no integrated exhalation system.
- ⇒ Follow the instructions for Use for the exhalation system.

4. Connect the mask to the breathing tube (see Instructions for Use for the breathing mask).



The proper position and arrangement of the mask on the face of the patient is critical for uniform use of the device.

4.2 Starting therapy

Requirement

Device is set up and connected (see "4.1 Setting up and connecting the device", page 14).

1. If the display is dark: Press any key briefly.
The device switches to standby.
 2. Briefly press the On/off key .
- or**
- If the autoSTART function is activated: Breathe into the mask.
Current therapy pressure appears in the display. Therapy starts.



For more information on autoSTART (see "5 Menu settings", page 22).

4.3 Ending therapy/switching off device

1. Briefly press the On/off key .
- or**
- If the autoSTART function is activated: Remove mask.
The device displays the therapy hours for the current day and then switches to standby.







To save energy, you can disconnect the power supply connector from the socket during the day.

4.4 Setting humidifier

Requirement

Humidifier is connected and filled with water (see Instructions for Use for humidifier).
The humidifier symbol  can be seen in the display.

1. Start therapy (see "4.2 Starting therapy", page 16).
The humidifier switches on automatically. The humidifier symbol  goes green.
2. To increase the humidifier stage: Press the  key.
3. To decrease the humidifier stage: Press the  key.
4. To switch off the humidifier: press the  key until  appears in the display



- The humidifier stage suitable for you depends on room temperature and humidity. If you have dry airways in the morning, heating output is set too low. If condensation has formed in the breathing tube in the morning, heating output is set too high.
- When the water level in the humidifier is too low, the device switches off the humidifier automatically.
- If the humidifier symbol is flashing, you need to fill the humidifier with water (see Instructions for Use for humidifier).

4.5 Performing the mask test

Condition: Therapy is running.

1. Press the menu key

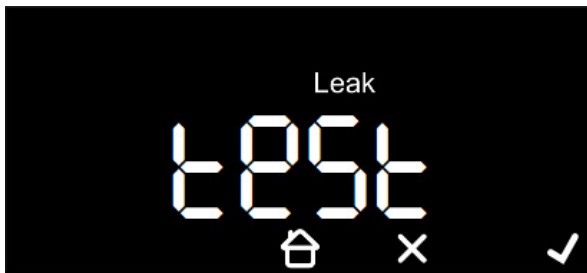

2. To start the mask test: Press . The remaining time and the mask test pressure are displayed.
3. If necessary: Press or key to change the mask test pressure.
4. Check mask for leaks.
Proper mask location: Green checkmark .
Mediocre mask location: Leak display turns orange.
Poor mask location: Leak display flashes.
5. If necessary: Adjust mask.
6. Wait until the device has completed the mask test.
or
Press

4.6 Switching softSTART on and off

Requirement

Therapy is running. softSTART is activated by the physician.

When softSTART is activated, the device automatically switches on every time therapy is started.

1. Press the softSTART key  briefly to switch on softSTART manually.



Remaining time and the current softSTART pressure are displayed.

2. Press the softSTART key  briefly to switch off softSTART.



- If you press the softSTART key  when the device is on standby, the device switches to the patient menu and you can adjust the softSTART time (see "5.2 Settings menu", page 22).
- To deactivate softSTART, set the softSTART time to **OFF**.

4.7 Using SD card (optional)

If an SD card is present, the device automatically saves the therapy data to the SD card. An SD card is not required to operate the device.

Requirement

The device is on standby.

NOTICE

Loss of data if power is interrupted!

If the device is disconnected from the power supply during the save process, data may be lost.

- ⇒ Leave the device connected to the power supply during the save process (SD card symbol  flashing).



NOTICE

Material damage as a result of malware!

Malware on the SD card may damage the software of the terminal device.

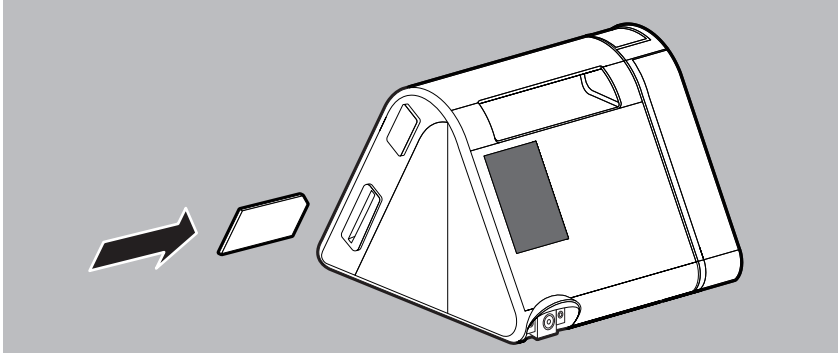
- ⇒ Do not use the SD card in combination with computers without antivirus protection.



1. Push the SD card into the SD card slot until you hear it engage. The SD card symbol  appears in the display.
2. To remove it, press the SD card briefly and remove the SD card. In doing so, please note: do not remove the SD card while the SD card symbol  is flashing.

4.8 Using the modem

The prisma SMART max and prisma SOFT max device variants have an integrated modem. An external modem of type WM090MW can be connected to the prisma SMART plus and prisma SOFT plus device variants.

When a modem is used, a wireless connection is set up automatically between the device and the prisma CLOUD platform. Once a day, all current therapy data and new settings are automatically called up and sent to prisma CLOUD.

However, you can also send therapy data manually at any time.

 When the modem is first used or first used in a new location, it can take up to half an hour to connect.

Sending therapy data manually

Requirement



The device is on standby.

The device is not in flight mode.

For prisma SMART plus and prisma SOFT plus: A modem is connected.

1. Press the menu key .



2. To call up the info menu: Press .
3. Use the arrow key  to scroll through the menu until the **SEndtiLL** menu entry appears.
This menu displays the date up to which the data have already been transmitted.
4. To send data, select the desired value in the **SEnd** menu:

DISPLAY	MEANING
NO	No data transmitted (canceled).
YES	Send all available new data since the last transmission (SEndtiLL menu).
ALL	Send all available data.

-  For more information about the modem, see the associated Instructions for Use.

Downloading updates

Available updates are downloaded automatically. Download progress is indicated by a progress bar in the display.

-  No therapy can take place during a download. If therapy is required, the download can be canceled. The download starts again automatically once therapy ends.

Condition for automatic update download

The device is on standby.

The device is not in flight mode.

For prisma SMART plus and prisma SOFT plus: A modem is connected.

An SD card with enough memory (> 5 MB) is plugged in.

-  If no SD card is available, "No Card" is shown in the display. If there is not enough memory, "Full Card" is shown in the display.



Determining telecode

Requirement

The device is on standby.

The device is not in flight mode.

For prisma SMART plus and prisma SOFT plus: A modem is connected.

1. Press the menu key .
To call up the info menu: Press .
2. Use the arrow key  to scroll through the menu until the **Code** menu entry appears. The telecode is a four-digit number.

Telesettings



You can check whether your device has telesettings enabled:

Requirement

The device is on standby.

The device is not in flight mode.

For prisma SMART plus and prisma SOFT plus: A modem is connected.

1. Press the menu key .
2. To call up the info menu: Press .
3. Use the arrow key  to scroll through the menu until the **teleCONF** menu entry appears.

: Telesetting is possible

: Telesetting is deactivated

5 Menu settings

5.1 Function of the keys



The keys of the device may have different functions. If there is a symbol above the key in the display (e.g. ✓ above the softSTART key), the key adopts the function of the symbol in question. If there is no symbol above the key (e.g. in the case of the + key), the key retains its original function.

5.2 Settings menu

5.2.1 Navigating in the menu

Requirement







The device is on standby.

1. Press the menu key .



2. To call up the settings menu: Press .
3. Make settings in the menu:

FUNCTION KEY	DESCRIPTION
	Scroll forward through menu

FUNCTION KEY	DESCRIPTION
	Scroll back through menu
	Increase value
	Reduce value
	Confirm value
	Discard value
	Exit menu. Switch back to start screen.

5.2.2 Menu structure

You can set the following parameters if your physician or your specialist dealer has enabled them for you:

PARAMETER	DESCRIPTION
softSTART (t)	Here you can set the time (5 min. to maximum 45 min.) for which ventilation pressure (min. 4 hPa) rises to therapy pressure during softSTART. If this function cannot be selected, it needs to be enabled by the physician or specialist dealer.
autoSTART	If autoSTART is activated (On), the device can be switched on by a breath (> 0.5 hPa) being taken into the mask and switches off automatically after 5 seconds without a breath being taken. Switch autoSTART to OFF to switch off this function.
softPAP	The device temporarily reduces therapy pressure in stages 1 (slight pressure drop) and 2 (standard pressure drop) before the transition to exhalation. softPAP breathing relief is suitable for patients who find it unpleasant to exhale against a high pressure. Switch softPAP to OFF to deactivate this function.
Tube type	Select the diameter of the tube type used here. If this function cannot be selected, it needs to be enabled by your physician or specialist dealer.
Time	You can set the current time here.
Format time display	Here you can set whether the time is to be displayed in the form 0-24 (24-h clock) or 0-12 (12-h clock).
Flight mode	You can activate (On)/deactivate (OFF) flight mode here. If flight mode is activated, wireless connection via the modem and the Bluetooth function are not available.

PARAMETER	DESCRIPTION
Bluetooth ¹	You can activate (On)/deactivate (OFF) Bluetooth here. Known devices are connected automatically. If no device has yet been connected via Bluetooth, a device search starts when the function is activated. This function can be disabled by the physician or specialist dealer.
Bluetooth pairing ¹	You can start the device search here (YES) if you want to replace the known device. Only available if Bluetooth is activated.
Delete Bluetooth device ¹	You can remove the known device connection here (YES).

¹ Availability depends on firmware version installed.



5.3 Info menu/reading out operating hours

Requirement

The device is on standby.

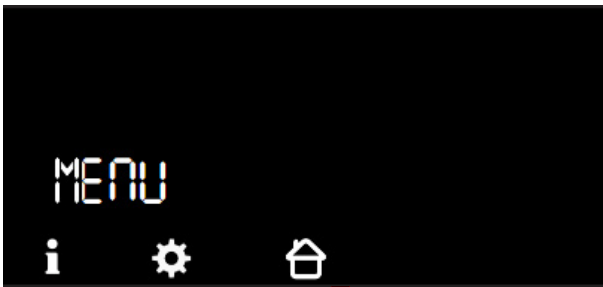
1. Press the menu key .



2. To call up the info menu: Press .
3. Navigate to the desired value with the  or  keys:

DISPLAY	MEANING
0000 h	Total operating hours of the device
1 d	Operating hours for the last day.
7 d	Operating hours for the last 7 days.
28 d	Operating hours for the last 28 days.
182 d	Operating hours for the last 182 days.
366 d	Operating hours for the last 366 days.



- Data are displayed only if they really are present in the device.
- Each therapy day begins and ends at 12 noon. Data recorded from midnight to 12 noon are assigned to the previous calendar day.

6 Hygiene treatment

WARNING

Risk of infection when the device is used again!

If the device is used by several patients, infections may be transmitted to the next patient.

⇒ If the device is used again: Have the device subjected to a hygiene treatment by the manufacturer or an authorized specialist dealer.

6.1 General information

- Wear appropriate safety gear for the disinfecting process.
- Refer to the Instructions for Use for the disinfectant used.
- Following a hygiene treatment by the authorized specialist dealer, the device is suitable for using again with other patients.

6.2 Cleaning intervals

INTERVAL	ACTION
Daily	Clean breathing tube (see "6.4 Hygiene treatment for breathing tube", page 28)
Weekly	Clean device (see "6.3 Hygiene treatment for device", page 26)
Monthly	Clean air filter (see "6.3.1 Cleaning air filter (gray filter)", page 27)
	Replace pollen filter (see "6.3.2 Replacing optional pollen filter (white filter)", page 27)
Every 6 months	Replace air filter
Annually	Replace breathing tube
As required	In the clinical sphere: Disinfect breathing tube (see "6.4 Hygiene treatment for breathing tube", page 28)
On change of patient	Have specialist dealer perform a hygiene treatment on the device before using it again.

6.3 Hygiene treatment for device

CAUTION

Risk of injury from electric shock!

Ingress of liquids may lead to a short-circuit, injure the user, and damage the device.

- ⇒ Disconnect the device from the power supply before the hygiene treatment.
- ⇒ Do not immerse the device and components in liquids.
- ⇒ Do not pour liquids over the device and components.

1. Subject the device and components to a hygiene treatment in accordance with the table below:

PART	CLEANING	DISINFECTING	STERILIZATION
Housing including device outlet port/inlet	Wipe down: Use water or mild detergent	Disinfect by wiping (recommended products: terralin® protect or perform advanced Alcohol EP)	Not permitted
High-gloss surfaces on the housing	Wipe down: Use water or mild detergent; do not use microfiber cloths		
Power cord and power supply unit	Wipe down: Use water or mild detergent		

2. Replace mask, breathing tube, air filter and pollen filter (if present).
3. Perform function check ([see "7 Function check", page 28](#)).

6.3.1 Cleaning air filter (gray filter)

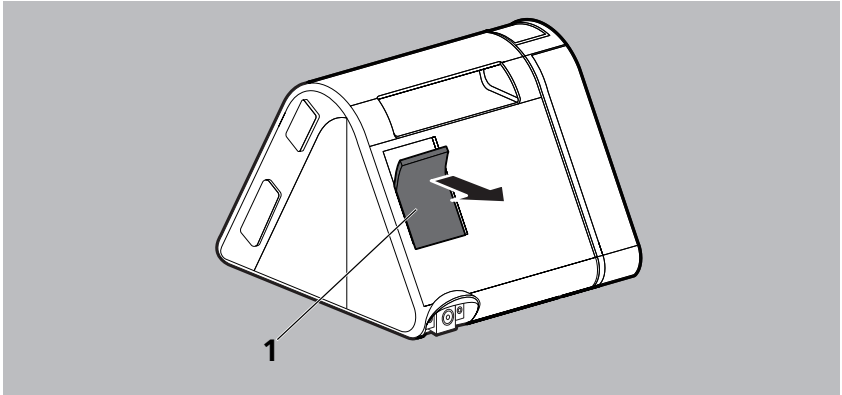

1. Clean air filter **1** under running water.
2. Allow air filter **1** to dry.

6.3.2 Replacing optional pollen filter (white filter)

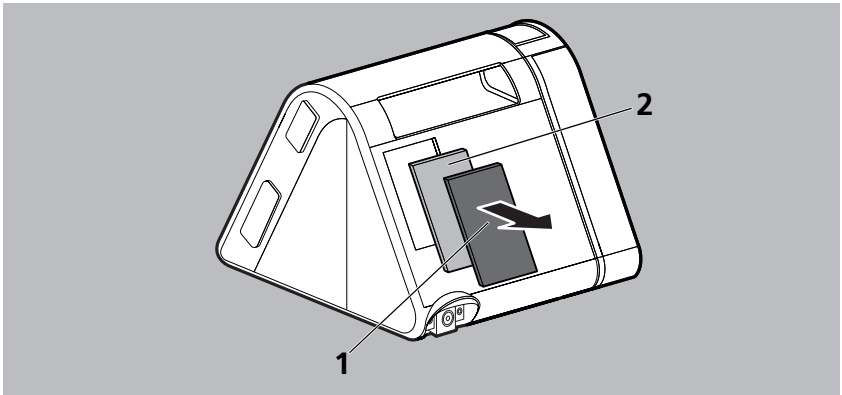

1. Remove air filter **1**.
2. Replace white pollen filter **2**.
3. Replace air filter **1** in the holder.

6.4 Hygiene treatment for breathing tube

NOTICE

Material damage as a result of ingress of liquids!

The device may be damaged by the ingress of liquids.

⇒ Use the breathing tube only when completely dry.

1. Subject the breathing tube to a hygiene treatment in accordance with the manufacturer's information.
2. Rinse off breathing tube with clean water and shake thoroughly.
3. Dry breathing tube.



If you use a heated breathing tube, see the Instructions for Use for the breathing tube.

7 Function check

Carry out a function check after every hygiene treatment and maintenance task, but at least every 6 months.

1. Check device for external damage.
2. Check connectors and cables for external damage.
3. Check that components are correctly connected to the device.
4. Connect device to the power supply and switch it on (see "4.1 Setting up and connecting the device", page 14).
5. If softSTART is active: press softSTART key  to cancel softSTART.
6. Close the opening of the breathing mask.
7. Compare the pressure shown in the display with the prescribed pressure.
8. If one of the items is not OK or pressure deviates by > 1 hPa: Do not use device and contact your specialist dealer.

8 Troubleshooting

If you are unable to remedy faults with the aid of the table, or in the event of unexpected operation or an incident, contact the manufacturer or your authorized specialist dealer. To avoid exacerbating the damage, do not continue operating the device.

You can find an explanation of the symbols which may appear in the display in the product description (see "3.4 Symbols in the display", page 12).

8.1 Device faults

FAULT/FAULT MESSAGE	CAUSE	REMEDY
No running noise, nothing in the display.	No power supply.	Check that the power cord is securely connected. Check function of socket.
Therapy cannot be started by taking a breath.	autoSTART function not activated.	Activate autoSTART function.
Device does not switch off after approx. 5 seconds once mask is removed.	autoSTART function may be restricted in the case of accessories with a high resistance.	Contact your specialist dealer.
softSTART cannot be switched on.	softSTART function is disabled.	Ask the physician whether the function can be enabled.
Device does not reach the set target pressure.	Air filter dirty.	Clean air filter. If necessary: Replace filter (see "6.3.1 Cleaning air filter (gray filter)", page 27).
	Breathing mask leaking.	Adjust headgear so that the mask is tight. If necessary, replace faulty mask.
No wireless symbol appears in the device display, not even over ten seconds after connection of the modem	Modem not started correctly.	Disconnect the modem from the device, reconnect after 5 seconds and wait about 15 seconds.
	Device firmware does not support modem.	Contact your specialist dealer.
	Modem faulty.	Contact your specialist dealer.
Device displays "NO PIC"	Device is not configured for data transmission.	Contact your specialist dealer.

FAULT/FAULT MESSAGE	CAUSE	REMEDY
When the therapy start key is pressed, the device displays "buSY"	Temporarily unable to interrupt process.	To start therapy straight away: Disconnect the modem.

8.2 Display messages

8.2.1 Error messages

If the message **Err (xxx)** appears in the display, look in the table for the error code displayed. Remedy the error in accordance with the description.

ERROR CODE	CAUSE	REMEDY
108	Device has lost the saved time	Contact specialist dealer and have device repaired.
204	Humidifier not working properly	Remove humidifier from device and re-connect it. If the message persists, contact an authorized specialist dealer and have device and humidifier checked.
601, 610 or 609	Faulty SD card	Remove and reinsert SD card. If the message persists, replace the SD card.
603	SD card full	Delete data from the SD card/Use new SD card.
612	Date of device deviates too far from server date	Contact your specialist dealer.
613	Device configuration via modem failed	Contact your specialist dealer.
628	Modem not supported.	Contact your specialist dealer.
622	Mobile wireless not configured	Contact your specialist dealer.
623	No mobile wireless network available	Try again later.
		Error occurs relatively frequently: Select a location with better reception.
		No remedy possible: Contact your specialist dealer.
624	No reliable link to remote data transmission station	Try again later. No remedy: Contact your specialist dealer.

ERROR CODE	CAUSE	REMEDY
627	Configuration of remote data transmission station faulty	Contact your specialist dealer.
629	Mobile wireless network not providing a data service	Try again later. No remedy: Contact your specialist dealer.
635	Inactive SIM card	Contact your specialist dealer.
701	Leak on humidifier or at the cover on the side	Remove humidifier or side cover from device and re-connect. If the message persists, contact an authorized specialist dealer and have device and humidifier checked.
826	Modem or Bluetooth module defective	Contact your specialist dealer.
All other error codes	Electronics problems	Disconnect the device from the power supply and reconnect it (see 4.1, p. 14). If the message persists, contact an authorized specialist dealer and have device and humidifier checked.

8.2.2 Information messages

If the message **Info (xxx)** appears in the display, look in the table for the info code displayed.

INFO CODE	CAUSE	REMEDY
640	Time set beyond 12:00 noon. Impossible, as the next therapy day starts at 12:00 and the assignment of therapy and calendar day has to be maintained.	Try the setting again in a few hours.
641	Time set before 12:00 noon. Impossible, as the current therapy day started at 12:00 and the assignment of therapy and calendar day has to be maintained.	Try the setting again in a few hours.
642	Time too far in the future or past (± 16 h UTC). Impossible, as assignment of therapy and calendar day has to be maintained.	Adjust device time in the opposite direction.

9 Transport and storage

Transport and store the device under the specified ambient conditions. Clean the device before storing it.

10 Disposal



Do not dispose of the product or any rechargeable batteries with domestic waste. To dispose of properly, contact a licensed, certified electronic waste disposal merchant. This address is available from your Environment Officer or from your local authority.

The device packaging (cardboard and inserts) can be disposed of in paper recycling facilities.

11 Appendix

11.1 Technical data

11.1.1 Device

SPECIFICATION	DEVICE
Product class to 93/42/EEC	Ila
Dimensions W x H x D in cm	17 x 13.5 x 18
Weight	1.34 kg
Temperature range	
- Operation	+5 °C to +40 °C
- Transport and storage	-25 °C to +70 °C
- Transport and storage at +70 °C	Allow to cool to room temperature for 1 hour before starting up.
- Transport and storage at -25 °C	Allow to heat to room temperature for 1 hour before starting up.
Rel. humidity, no condensation for	
- Operation	10 % to 95 %
- Transport and storage	10 % to 95 %
Air pressure range	700 hPa to 1060 hPa, corresponds to an altitude of 3000 m above mean sea level; adapts automatically to altitude
Connection diameter of breathing tube in mm	19.5 (fits standard tapered connector)
Power capacity	Max. 40 VA
System interface	24 V DC Max. 5 VA
Current consumption in operation (therapy)	
240 V AC	0.16 A
100 V AC	0.36 A
on standby	
240 V AC	0.035 A
100 V AC	0.061 A

SPECIFICATION	DEVICE
Classification to IEC 60601-1-11: Class of protection against electric shock	Protection class II
Degree of protection against electric shock	Type BF
Protection against damaging ingress of water and solids	IP21
Classification to IEC 60601-1: Operating mode	Continuous duty
Application part	Breathing mask
Mean sound pressure level/ operation to ISO 80601-2-70	Approx. 26 dB(A) at 10 hPa (corresponds to a sound power level of 34 dB(A))
Mean sound pressure level/ operation to ISO 80601-2-70 with humidifier	Approx. 27.5 dB(A) at 10 hPa (corresponds to a sound power level of 35.5 dB(A))
prisma SMART operating modes	CPAP APAP softPAP (breathing relief, can be set in 2 levels)
prisma SOFT operating modes	CPAP softPAP (breathing relief, can be set in 2 levels)
CPAP operating pressure range	4 hPa to 20 hPa Adjustable in 0.5 hPa increments
Pressure accuracy	$\pm(0.25 \text{ hPa} + 3 \% \text{ of the measured value})$
$P_{\text{lim}_{\text{max}}}$ (maximum pressure in the event of a fault)	$\geq 40 \text{ hPa for } < 1\text{s}, \geq 30 \text{ hPa for } < 5\text{s}$

SPECIFICATION	DEVICE	
<p>Maximum flow rate to ISO 80601-2-70</p> <p>Test pressures:</p> <p>4 hPa 8 hPa 12 hPa 16 hPa 20 hPa</p> <p>4 hPa 8 hPa 12 hPa 16 hPa 20 hPa</p>	<p>Pressure measured at the patient connection opening at a flow rate of 40 l/min</p> <p>22 mm tube (19 mm)</p> <p>3.9 hPa 7.9 hPa 11.8 hPa 15.8 hPa 19.8 hPa</p> <p>15 mm tube</p> <p>3.9 hPa 7.8 hPa 11.8 hPa 15.8 hPa 19.7 hPa</p>	<p>Mean flow rate prevailing at the patient connection opening</p> <p>150 l/min 174 l/min 174 l/min 172 l/min 164 l/min</p> <p>109 l/min 113 l/min 113 l/min 112 l/min 112 l/min</p>
<p>Heating of respiratory air</p>	<p>Max. +3 °C</p>	
<p>Stability of dynamic pressure (short-term precision) at 10 breaths/min to ISO 80601-2-70 at</p> <p>4 hPa 8 hPa 12 hPa 16 hPa 20 hPa</p>	<p>With 22 mm (19 mm) breathing tube, with and without humidifier:</p> <p>$\Delta p \leq 0.3$ hPa $\Delta p \leq 0.4$ hPa $\Delta p \leq 0.5$ hPa $\Delta p \leq 0.5$ hPa $\Delta p \leq 0.6$ hPa</p>	<p>With 15 mm breathing tube, with and without humidifier:</p> <p>$\Delta p \leq 0.3$ hPa $\Delta p \leq 0.5$ hPa $\Delta p \leq 0.6$ hPa $\Delta p \leq 0.7$ hPa $\Delta p \leq 0.7$ hPa</p>
<p>Stability of dynamic pressure (short-term precision) at 15 breaths/min to ISO 80601-2-70 at</p> <p>4 hPa 8 hPa 12 hPa 16 hPa 20 hPa</p>	<p>With 22 mm (19 mm) breathing tube, with and without humidifier:</p> <p>$\Delta p \leq 0.4$ hPa $\Delta p \leq 0.5$ hPa $\Delta p \leq 0.5$ hPa $\Delta p \leq 0.6$ hPa $\Delta p \leq 0.7$ hPa</p>	<p>With 15 mm breathing tube, with and without humidifier:</p> <p>$\Delta p \leq 0.4$ hPa $\Delta p \leq 0.6$ hPa $\Delta p \leq 0.8$ hPa $\Delta p \leq 0.9$ hPa $\Delta p \leq 0.9$ hPa</p>

SPECIFICATION	DEVICE	
Stability of dynamic pressure (short-term precision) at 20 breaths/min to ISO 80601-2-70 at	With 22 mm (19 mm) breathing tube, with and without humidifier:	With 15 mm breathing tube, with and without humidifier:
4 hPa	$\Delta p \leq 0.5$ hPa	$\Delta p \leq 0.6$ hPa
8 hPa	$\Delta p \leq 0.6$ hPa	$\Delta p \leq 0.8$ hPa
12 hPa	$\Delta p \leq 0.7$ hPa	$\Delta p \leq 0.9$ hPa
16 hPa	$\Delta p \leq 0.8$ hPa	$\Delta p \leq 1.0$ hPa
20 hPa	$\Delta p \leq 0.8$ hPa	$\Delta p \leq 1.1$ hPa
Stability of static pressure (long-term precision) to ISO 80601-2-70 (section 201.12.1.101, b, 2)	$\Delta p < 0.25$ hPa \pm 3 % of the measured value	
Maximum additional oxygen flow rate	4 l/min	
Pollen filter up to 1 μ m up to 0.3 μ m	Filter class E10 ≥ 99.5 % ≥ 85 %	
Service life of pollen filter	approx. 250 h	
SD card	Memory size 2 GB to 32 GB can be used, interface compatible with SD physical layer version 2.0	
Materials	Flame-retardant technical thermoplastics:	
Housing	ASA (acrylonitrile/styrene/acrylate copolymers) with PC (polycarbonate)	
Filter	Polyester foam	
Breathing tube	Polyethylenes Thermoplastic elastomers	
	No parts contain latex.	
Service life	6 years	
Servicing	If used in accordance with the intended use, the device requires no servicing during the service life quoted. If the device is used beyond its service life, it needs checking by an authorized specialist dealer.	

TOLERANCES FOR MEASURED VALUES

Pressure:	$\pm 0.75\%$ of measured value or ± 0.1 hPa
Flow:	$\pm 2\%$ of actual value
Temperature:	± 1.6 °C
Sound pressure level and sound power level	± 1.1 dB(A)

The right to make design modifications is reserved.

All flow rate and volume values determined under STPD conditions

The device uses the following open-source software: FreeRTOS.org

The software of this device contains code which is subject to the GPL. You can see the GPL source code and the GPL on request.

11.1.2 Technical data for power supply unit

SPECIFICATION	POWER SUPPLY UNIT
Input voltage/maximum current	100 V - 240 V AC, 2 A - 1 A
Frequency	50 Hz - 60 Hz
Output voltage/maximum current	24 V DC, 2.5 A

11.1.3 Pressure/volume curve

p/V curve at AV = 0.5 l and f = 20/min

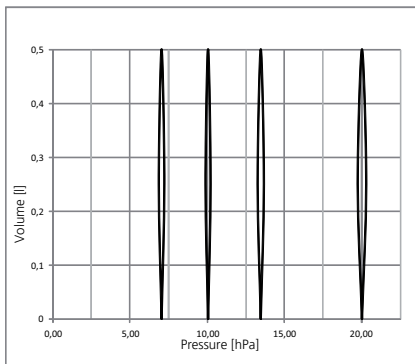

11.1.4 Pneumatic diagram

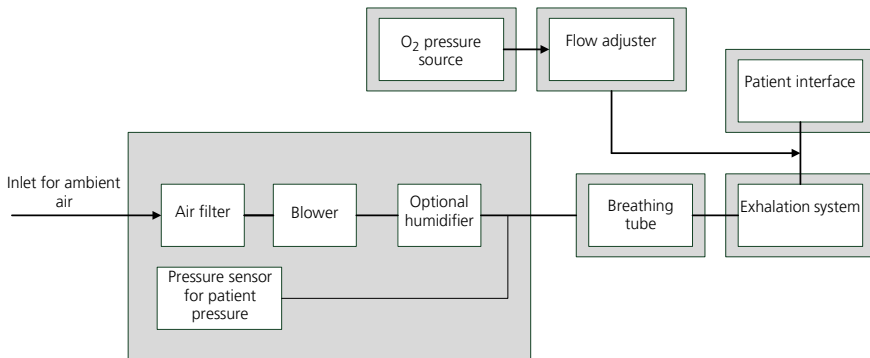

11.2 Emission of electromagnetic interference

Guidelines and manufacturer declaration - emission of electromagnetic interference

The device can be used in both static and mobile operation, in both domestic and appropriate hospital environments.
 In the domestic sphere, the device may cause radio interference, possibly making it necessary to take suitable remedial measures, such as realigning, rearranging or shielding the device, for example, or filtering the connection to the premises.

Measurements of interference emission	Compliance
HF emissions to CISPR 11	Group 1
HF emissions to CISPR 11	Class B
Emission of oscillations IEC 61000-3-2	Class A
Emission of voltage fluctuations/flicker to IEC 61000-3-3	Complies

11.3 Electromagnetic interference immunity





Guidelines and manufacturer declaration - electromagnetic interference immunity		
<p>The device can be used in both static and mobile operation, in both domestic and appropriate hospital environments.</p> <p>In a domestic environment, the device may cause radio interference, possibly making it necessary to take suitable remedial measures, such as realigning the device, for example.</p>		
Interference immunity tests	IEC 60601 test level	Compliance level
Discharge of static electricity (ESD) to IEC 61000-4-2	± 8 kV contact discharge ± 15 kV air discharge	± 8 kV contact discharge ± 15 kV air discharge
Electrical fast transients/bursts to IEC 61000-4-4	± 2 kV for power supply cables ± 1 kV for input and output cables Connection duration ≥ 60 s Burst frequency: 100 kHz	± 2 kV for power supply cables ± 1 kV for input and output cables Connection duration ≥ 60 s Burst frequency: 100 kHz
Surge immunity to IEC 61000-4-5	Source impedance: 2 Ω, 18 μF: 0.5 kV, 1 kV Number of surges: 5 surges/ phase angle Phase angle: 0°, 90°, 180°, 270° Repetition rate: 60 s	Source impedance: 2 Ω, 18 μF: 0.5 kV, 1 kV Number of surges: 5 surges/ phase angle Phase angle: 0°, 90°, 180°, 270° Repetition rate: 60 s
Voltage dips/short interruptions and variations in power supply to IEC 61000-4-11	Number of voltage drops: 3 drop levels/duration: 30 %/500 ms 60 %/100 ms 100 %/20 ms 100 %/10 ms at 0°, 45°, 90°, 135°, 180°, 225°, 270° and 315°	Number of voltage drops: 3 drop levels/duration: 30 %/500 ms 60 %/100 ms 100 %/20 ms 100 %/10 ms at 0°, 45°, 90°, 135°, 180°, 225°, 270° and 315°
Magnetic field at power supply frequency (50/60 Hz) according to IEC 61000-4-8	30 A/m Duration: 30 s per axis Axes: x axis, y axis, z axis	30 A/m Duration: 30 s per axis Axes: x axis, y axis, z axis









11.4 Electromagnetic interference immunity for medical electrical devices and medical electrical systems







Guidelines and manufacturer declaration - electromagnetic interference immunity		
<p>The device can be used in both static and mobile operation, in both domestic and appropriate hospital environments.</p> <p>In a domestic environment, the device may cause radio interference, possibly making it necessary to take suitable remedial measures, such as realigning the device, for example.</p>		
Interference immunity tests	IEC 60601 test level	Compliance level
Conducted HF interference to IEC 61000-4-6	10 V _{effective value} 150 kHz to 80 MHz within ISM bands	10 V
Radiated HF interference to IEC 61000-4-3	10 V/m 80 MHz to 2.7 GHz 80 % AM at 2 Hz	10 V/m
Magnetic field at power supply frequency (50/60 Hz) according to IEC 61000-4-8	30 A/m	30 A/m

11.5 Markings and symbols

The following symbols may be applied to the device, the device ID plate, accessories or packaging.

SYMBOL	DESCRIPTION
	Serial number
	Date of manufacture
	Follow Instructions for Use
	Inlet; do not block openings
	Follow Instructions for Use

SYMBOL	DESCRIPTION
	Slot for the SD card
	USB port
	Indicates the On/off key
TYP	Type designation of the device
IP21	Degree of protection against contact with a finger. Product is protected against vertically-falling drops of water.
	Degree of protection against electric shock: Protection class II product
	Do not dispose of the product in domestic waste
	Suitable for use in aircraft. Meets RTCA/DO-160G Section 21, Category M.
	Application part type BF
	Manufacturer
CE 0197	CE symbol (confirms that the product conforms to the applicable European directives/regulations)
INPUT	Input voltage
OUTPUT: ---	Output voltage/direct voltage
	Only for indoor use
CE	CE symbol (confirms that the product conforms to the applicable European directives/regulations)
MD	Indicates the product is a medical device

SYMBOL	DESCRIPTION
	Unique device identifier (uniform product code for medical devices)
	Non-ionizing radiation
	Permitted temperature range for transport and storage
	Permitted humidity range for transport and storage
	Reuse on a single patient
	Protect from moisture
	Fragile. Do not throw or drop.

11.6 Scope of supply

A current list of scopes of supply can be ordered on the website of the manufacturer or through your specialist dealer.

The parts below are included in the standard scope of supply:

PART	ARTICLE NUMBER
Basic device	Varies depending on device variant
Breathing tube (varies depending on device variant)	WM 24445/29988
Power cord	WM 24133
Power supply unit	WM 24480
Set, 2 air filters	WM 29928
Set, 12 pollen filters (varies depending on device variant)	WM 29652
SD card	WM 29794
Instructions for Use	LMT 65651
prismaBAG basic bag	WM 29708

11.7 Accessories and replacement parts

A current list of accessories and replacement parts can be ordered on the website of the manufacturer or through your authorized specialist dealer.

11.8 Warranty

Löwenstein Medical Technology gives the customer a limited manufacturer warranty on a new original Löwenstein Medical Technology product and on any replacement part fitted by Löwenstein Medical Technology in accordance with the warranty conditions applicable to the product in question and in accordance with the warranty periods from date of purchase listed below. The warranty conditions are available on the website of the manufacturer. We will also send you the warranty conditions on request.

In the event of a claim under warranty, contact your specialist dealer.

PRODUCT	WARRANTY PERIODS
Devices including accessories (except masks)	2 years
Masks including accessories, rechargeable batteries, batteries (unless quoted differently in the technical documentation), sensors, patient circuits	6 months
Disposable products	None

11.9 Declaration of Conformity

The manufacturer Löwenstein Medical Technology GmbH + Co. KG Kronsaaßweg 40, 22525 Hamburg, Germany hereby declares that the product complies with the relevant regulations of Directive 93/42/EEC governing medical devices.

The manufacturer Löwenstein Medical Technology GmbH + Co. KG Kronsaaßweg 40, 22525 Hamburg, Germany hereby declares that the product complies with the relevant regulations of Directive 2014/53/EEC governing the provision of wireless equipment.

TECHNOLOGY	FREQUENCY RANGE	OUTPUT LEVEL
GSM850/900	850 MHz to 900 MHz	33 dBm
DCS1800/PCS1900	1800 MHz to 1900 MHz	30 dBm
LTE B1, B2, B3, B4, B5, B8, B12, B13, B18, B19, B20, B25, B26, B27, B28, B66, B71, B85	700 MHz to 2100 MHz	25 dBm
Bluetooth Low Energy 5.0	2400 MHz to 2483.5 MHz	< 20 dBm

The unabridged text of the Declaration of Conformity can be found on the website of the manufacturer.

CE 0197

**Löwenstein Medical
Technology GmbH + Co. KG**
Kronsaalsweg 40
22525 Hamburg, Germany
T: +49 40 54702-0
F: +49 40 54702-461
www.loewensteinmedical.de



LMT 65651

